

**CONTINUOUS DIMMING MOTION SENSOR
& COMPATIBLE REMOTE PROGRAMMER**
MSITXLRD509 & RMTITXSRP280



PRODUCT DESCRIPTION:

The Continuous Dimming (SmartDIM) Motion Sensor is a line voltage switching occupancy sensor with 0-10V output for dimmable ballast or LED driver control. This sensor is fully programmable with multi-level high/low or continuous dimming control. The continuous dimming function maintains overall ambient light level within the preset range. The sensor comes available with multiple mounting and interchangeable lens options.

FEATURES:

- 2-way IR Remote Programmable Sensor Setting
- Hybrid Switching for Controlling Loads with HIC
- Continuous or Multi-Level High/Low Dim Control
- Remote Programmable Range up to 30ft
- Available with a Variety of Mounting Options
- Available with Interchangeable Lens Options

ORDERING:

ORDER CODE	MODEL NUMBER	DESCRIPTION
1409226	MSITXLRD509SWCNTRL	INTEGRATED, IP66 RATED SENSOR
103491	MSITXLRD509SPASSY	EXTERNALLY MOUNTED, IP66 RATED HOUSING
103492	RMTITXSRP280	REMOTE SENSOR PROGRAMMER

*LUMINAIRES ORDERED WITH INSTALLED SENSOR WILL COME WITH APPLICABLE LENS. FOR MORE DETAILS, CONTACT YOUR MAXLITE REPRESENTATIVE

SPECIFICATIONS:

MSITXLRD509

ITEM	SPECIFICATION		
GENERAL INFORMATION	Power Supply	100/120/230/277VAC, 50/60HZ	
	Max Load	Incandescent/Halogen	800/1200W(VA)@120/277V
		Fluorescent Ballast/CFL	800/1200W(VA)@120/277V
		Ballast Electronic (LED	540/1200VA@120/277V
	Infrared Sensor	Omni-directional quad element pyroelectric	
	Photo Sensor	Digital Ambient Light Sensor	
	HIC Protection	MAX. 80A FOR 16.7 msec.	
	Detectable Speed	1~10 ft./sec. (0.3 ~ 3 m/sec.)	
	Mounting Height	SUBJECT TO LENSE TYPE APPLIED	
	Deflection Range	SUBJECT TO LENSE TYPE APPLIED AND HEIGHT	
	Remote Range	33 ft. (10m) indoor, no backlight	
	OP Humidity	MAX 95% RH	
	OP Temperature	-40°F~158°F	
	Dimensions	2.36"x H1.45"	

SETTINGS:

SETTINGS	DESCRIPTION	OPTIONS (*DENOTES FACTORY DEFAULT.)
CONTROL	The mode the sensor will control	ON/OFF, OSO, OSLA, OSLATO*
AMBIENT FC	The ambient light level the sensor will perform the control	DISABLED
OFF DELAY	The delay time the sensor will keep the light at low dim	1/3/5/10*/15/20/30/60 min
TIME OFF	The delay time the sensor is set to turn off or dim the light after the area is vacant	3/5/10*/15/20/30/45/60 min
HIGH DIM	The output level set to control the light during occupancy	50/55/60/65/70/80/90/100%/SmartDIM*
LOW DIM	The output level set to control the light when the space is vacant	0/5/10/15/20/25/30*/40%
RAMP UP	The speed of increasing the lighting output to HIGH DIM level	INSTANT*/SOFT/SLOW
FADE DOWN	The speed of decreasing the lighting output to LOW DIM level or off	INSTANT/SOFT*/SLOW
SENSITIVITY	The sensitivity of occupancy sensor	HIGH*/NORMAL/LOW
BURN-IN	The duration of burn-in test	STOP*/12/24/48/72/96H/MANUAL

CONTROL MODES:

- ON/OFF: ON-OFF Switching
- OSO: Occupancy Sensing Only
- OSLA: Occupancy Sensing at Low Ambient
- OSLATO: Occupancy Sensing at Low Ambient with Time-Off

APPLICATIONS:

1. The sensor is more sensitive to the movements “crossing” the detection zones than “toward” or “away” the sensor unit. To obtain better sensitivity, avoid placing the sensor in line with occupant path, if possible.
2. The closer the movement is to the sensor, the more sensitive the sensor is. The higher the sensor is installed, the larger movement is required to be detected.
3. Ensure to place the sensor at least at 1.5m (5 ft.) away from air supply ducts as rapid air flow may cause false activations.
4. The sensor cannot “see” the movements behind obstacles, such as furniture, shelf, glass or partition. As a general rule, each occupant should be able to clearly view the sensor unit.
5. For open office areas with partition which could block the sensor view to occupant movements, it is best to place the sensors over the intersection of multiple workstations. For large areas of open office or space, place multiple sensors so that there is overlap coverage with each adjacent sensor.

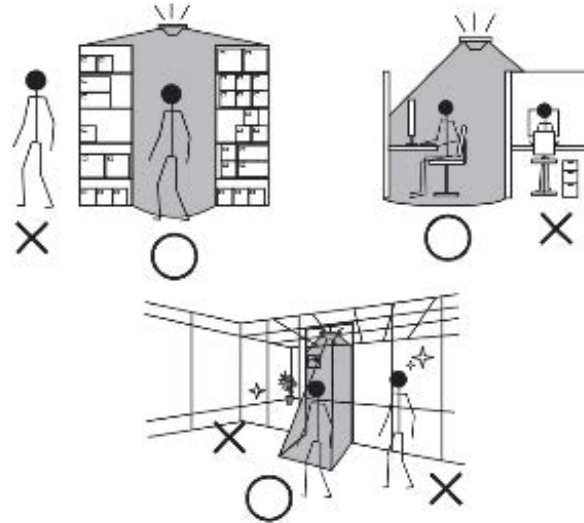

WIRING DIAGRAM:

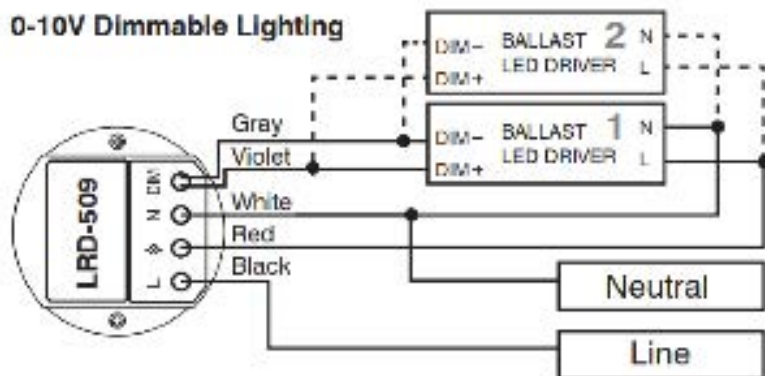
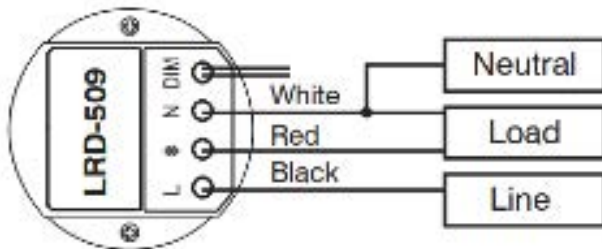







RMTITXSRP280 REMOTE PROGRAMMER:

SPECIFICATIONS:

Power supply	2 x AAA 1.5V battery, Alkaline preferred
Rubber housing	SRP-280 must be installed in housing
Display unit	128 x 96 dot matrix LCD
Communication	940 nm Infrared Tx & Rx
Upload range	Up to 10 m (33 ft.)
Download range	Subject to the type of sensor applied
Uploading time	Approx. 6 sec.
Downloading time	Approx. 10 sec.
LCD auto-off time	Approx. 1 min.
Op. temperature	0°C~50°C (32°F~122°F)
Dimensions	130 x 50 x 21 mm (5.1" x 2" x 0.8")

KEY DESCRIPTIONS:

KEY		FUNCTION
	UP	<ul style="list-style-type: none"> Enter into UPLOAD page Select the setting bar (up)
	DOWN	<ul style="list-style-type: none"> Enter into DOWNLOAD page Select the setting bar (down)
	LEFT	<ul style="list-style-type: none"> Turn the light ON (auto-off) Change setting (decrease)
	RIGHT	<ul style="list-style-type: none"> Turn the light OFF manually Change setting (increase)
	ENTER	<ul style="list-style-type: none"> Confirm the command Upload setting
	BACK	<ul style="list-style-type: none"> Back to previous page

CONFIGURABLE TABLE:

The following table highlights all settings and options available for the remote to configure. Certain settings and parameters may not be available on specific type of sensor with specific control mode selected. For the available settings and options of specific sensor, please refer to the installation instruction of the sensor.







Settings	Description	Setting Options
CONTROL	The mode that the sensor will control.	ON/OFF, OSD, OSLA, OSLATO, D8VM, D8G
AMBIENT LUX	The ambient light level that sensor will perform the control.	7 levels, from dark to bright (1-7) and D-SABLE
OFF DELAY	The delay time that sensor will turn off or dim the light.	1/3/5/10/15/20/30/60 min.
TIME OFF	The delay time that sensor will keep the light at low dim level after the OFF delay time elapsed.	3/5/10/15/20/30/45/60 min.
HIGH DIM	The output level set to control the light during occupancy, or when ambient light is below the threshold for daylight sensor.	50/55/60/65/70/80/90/100%/SmartDIM
LOW DIM	The output level set to control the light when the space is vacant, or when ambient light is above the threshold for daylight sensor. Low dim setting will be disabled if sensor is operating in SmartDIM control.	0/5/10/15/20/25/30/40%
RAMP UP	The speed of increasing the lighting output to HIGH DIM level.	INSTANT/SOFT/SLOW
FADE DOWN	The speed of decreasing the lighting output to LOW DIM level or off.	INSTANT/SOFT/SLOW
VM-TB	Set the duration before Virtual Midnight. Only available with Daylight Sensor.	0.5-6 Hour, 0.5 H/step
VM-TA	Set the duration after Virtual Midnight. Only available with Daylight Sensor.	0.5-6 Hour, 0.5 H/step
SENSITIVITY	Set the sensitivity of occupancy sensor.	HIGH/NORMAL/LOW
ON DELAY	The delay time that sensor is set to turn on the load after occupant is detected or after the ambient light is below set threshold for daylight sensors. Not applicable for lighting control occupancy sensors.	OFF/10/20/30/40/60/90/120 sec.
BURN-IN	Set the duration for burn-in test. To conduct the burn-in test with uncertain duration, select MANUAL.	STOP/12/24/48/72/96HR/MANUAL
TEST (10-MIN)	The sensor will control the light as the mode selected and parameters configured, but with shorter delay times (10 seconds) for testing and function verification. Sensor will automatically return to its normal control after 10 minutes or whenever STOP command is given.	STOP/START
SAVE AS	Save the settings as an EZ-SET profile for future use.	EZ-SET 1, 2, 3, 4
RECALL	Recall the EZ-SET profile saved.	DEFAULT, EZ-SET 1, 2, 3, 4
DEFAULT	Resume the factory default settings for REMOTE or SENSOR.	REMOTE/SENSOR
DEVICE INFO	Call out the information of REMOTE or SENSOR.	REMOTE/SENSOR

RMTITXSRP280 REMOTE PROGRAMMER:

SPECIFICATIONS:

Power supply	2 x AAA 1.5V battery, Alkaline preferred
Rubber housing	SRP-280 must be installed in housing
Display unit	128 x 96 dot matrix LCD
Communication	940 nm Infrared Tx & Rx
Upload range	Up to 10 m (33 ft.)
Download range	Subject to the type of sensor applied
Uploading time	Approx. 6 sec.
Downloading time	Approx. 10 sec.
LCD auto-off time	Approx. 1 min.
Op. temperature	0°C~50°C (32°F~122°F)
Dimensions	130 x 50 x 21 mm (5.1" x 2" x 0.8")

KEY DESCRIPTIONS:

KEY	FUNCTION
	UP <ul style="list-style-type: none"> Enter into UPLOAD page Select the setting bar (up)
	DOWN <ul style="list-style-type: none"> Enter into DOWNLOAD page Select the setting bar (down)
	LEFT <ul style="list-style-type: none"> Turn the light ON (auto-off) Change setting (decrease)
	RIGHT <ul style="list-style-type: none"> Turn the light OFF manually Change setting (increase)
	ENTER <ul style="list-style-type: none"> Confirm the command Upload setting
	BACK <ul style="list-style-type: none"> Back to previous page

BASIC OPERATION:

To operate the SRP-280 TRANS Sensor Remote Programmer, correctly install two AAA batteries into the compartment. A startup page will display the remote info for 1 minute. You can press any key to enter into the MAIN MENU immediately. Under the MAIN MENU and respective setting pages, use the keys to navigate, select, and enter the settings of the sensor as instructed.

NOTE:

- The LCD will automatically shut off in 1 minute after the last key operation to conserve battery power. Pressing any key will wake up the LCD to the last page immediately. Replace with two new batteries when "low battery" sign appears after LCD wake-up.
- To avoid changing the setting of nearby sensor, always execute upload and download right under the target sensor.

MAIN MENU:

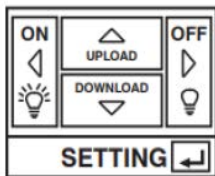

The MAIN MENU provides a quick selection of the following operations by pressing the respective keys.

SETTING:

The SETTING page contains all available settings and parameters for remote sensors. It allows you to change the available control, settings, and operation of the sensor from factory default or current settings.

**RMTITXSRP280 REMOTE PROGRAMMER:
SETTINGS:**

Change a single setting of sensor(s)

1. Enter the SETTING page, and navigate to the desired setting by pressing or .
2. Press or to select the new parameter.
3. Aim at the target sensor and press to upload the new setting.
4. To change the same setting for more sensors, repeat step 3 on all others.

Change multiple settings of sensor(s)

1. Enter the SETTING page, and navigate to the first setting by pressing or .
2. Press or to select the new parameter.
3. Move to the next setting and select the new parameter as step 2.
4. Repeat step 3 to select all parameter settings.
5. Press and enter into the UPLOAD page.
6. Select CURRENT SETTING and press to confirm. Aim at the target sensor and press again to upload the new settings.
7. To change more sensors with the same settings, repeat step 6 on all sensors.

Set/Change the SmartDIM level

1. Enter the SETTING page, and navigate to the HIGH DIM by pressing or .
2. Select the HIGH DIM setting at SmartDIM by pressing or .
3. Press to select the SmartDIM level setting.
4. Aim at the sensor and press to decrease, or to increase the SmartDIM level.
5. Once the desired ambient light level reaches, aim at the sensor and press to confirm the setting.

NOTE

- Once SmartDIM is selected, the LOW DIM setting will be disabled.
- The connected light will flash (on and off two times) to acknowledge a successful SmartDIM setting. Do NOT execute any upload/download operation while flashing.
- Press and hold or will change the lighting level in faster speed.

Resume the remote/sensor with factory default

1. Enter the SETTING page, and navigate to the DEFAULT by pressing or .
2. Select REMOTE or SENSOR by pressing or .
3. Press to enter the confirmation page. Select YES and press again to activate default process.

NOTE: To resume an installed sensor with factory default settings, aim at the sensor while press .

WARNING: All existing EZ-SET profiles stored in the remote will be replaced with factory default settings after executing step 3.

UPLOAD

The upload function allows you to configure the sensor with all settings in one operation. You may select CURRENT SETTING or any EZ-SET profile for uploading. CURRENT SETTING includes all existing settings on the SETTING page.

Upload the current setting to sensor(s)

1. After setting all parameters (except SmartDIM level) in the SETTING page, go to UPLOAD page.
2. Select CURRENT SETTING and press to confirm.
3. Aim at the target sensor and press again to upload. Hold the remote in position until LCD display one of the below.

- **UPLOAD OK** Upload succeed. The connected light will flash to acknowledge a successful upload. Do NOT execute any upload/download operation while flashing.
- **UPLOAD FAIL** The IR communication may have failed due to sudden obstruction, interruption or misalignment. Ensure no obstacle is blocking the sensor and remote, try again.
- **SENSOR UNMATCHED** The upload setting is not available on the target sensor. If so, download the current settings from the sensor and change with new parameters, then upload again.

NOTE

SmartDIM level can only be set and changed via SETTING operation. Please refer to the section of "Set/Change the SmartDIM level".

RMTITXSRP280 REMOTE PROGRAMMER:

EZ SET PROFILE:

The remote comes with a DEFAULT and four EZ-SET profiles with factory preset control mode and parameters. You may use any applicable profile or recall an existing profile, change with desired parameters and save as a new EZ-SET profile to configure the installed sensors.

PROFILE	DEFAULT	EZ-SET 1	EZ-SET 2	EZ-SET 3	EZ-SET 4
CONTROL	OSLATO	ON/OFF	OSO	OSLA	OSLATO
AMBIENT LUX	DISABLE	DISABLE	N/A	3	5
OFF DELAY	10 MIN	10 MIN	3 MIN	5 MIN	5 MIN
TIME OFF	10 MIN	N/A	N/A	N/A	3 MIN
HIGH DIM	SmartDIM 	N/A	70%	70%	SmartDIM
LOW DIM	-	N/A	30%	30%	-
RAMP UP	INSTANT	N/A	INSTANT	INSTANT	INSTANT
FADE DOWN	SOFT	N/A	SOFT	SOFT	SOFT
VM-TB	N/A	N/A	N/A	N/A	N/A
VM-TA	N/A	N/A	N/A	N/A	N/A
SENSITIVITY	HIGH	HIGH	HIGH	HIGH	HIGH
ON DELAY	N/A	N/A	N/A	N/A	N/A

Save as a new EZ-SET profile

1. Enter the SETTING page, and navigate to the desired setting by pressing or
2. Set the parameter of selected setting by pressing or
3. After all parameters are set, navigate to SAVE AS section.
4. Select the profile (EZ-SET 1, 2, 3, 4) by pressing or
5. Press to save the settings in the selected EZ-SET profile.

Recall an EZ-SET profile

1. Enter the SETTING page, and navigate to the RECALL by pressing or
2. Select the profile you want to recall by pressing or
3. Press to recall the selected EZ-SET profile.

NOTE: The DEFAULT profile can be recalled and used as a template for changing parameters, and saving as a new EZ-SET profile.

DOWNLOAD:

The download function allows you to check the settings of an installed sensor and the current dim level of the connected lighting.

Download the sensor settings

1. Enter the DOWNLOAD page. Select SETTING and press
2. Aim at the sensor and press again. Hold the remote in position for about 10 seconds until LCD display one of the below;
 - **DOWNLOAD OK** Download successful. Press to review the settings.
 - **DOWNLOAD FAIL** The IR communication may have failed due to sudden obstruction, interruption or misalignment. Ensure no obstacle is blocking the sensor and remote, try again.

Duplicate the sensor settings from one to another

1. Download the settings from a configured sensor.

NOTE: Check if all settings are correct by scrolling the SETTING page prior duplication.
2. Go to the UPLOAD page. Select CURRENT SETTING and press to confirm.
3. Aim at the target sensor and press again to upload the settings as instructed.

Download the current dim level

1. Enter the DOWNLOAD page. Select CURRENT DIM and press
2. Aim at the sensor and press again. LCD will display the percentage of current lighting output.