

IntelliMax Node Controller

The **IntelliMax Node** controller enables wireless light level control on a zone or individual fixture basis. The node reduces energy consumption through manual control, vacancy detection, daylighting, and other wireless load shedding strategies compatible with the IntelliMax gateway.

The IM-NODE operates on a ZigBee network and is compatible with IntelliMax ZigBee-based third-party components. The node provides a compelling, cost-effective solution for compliance with the latest energy regulations.

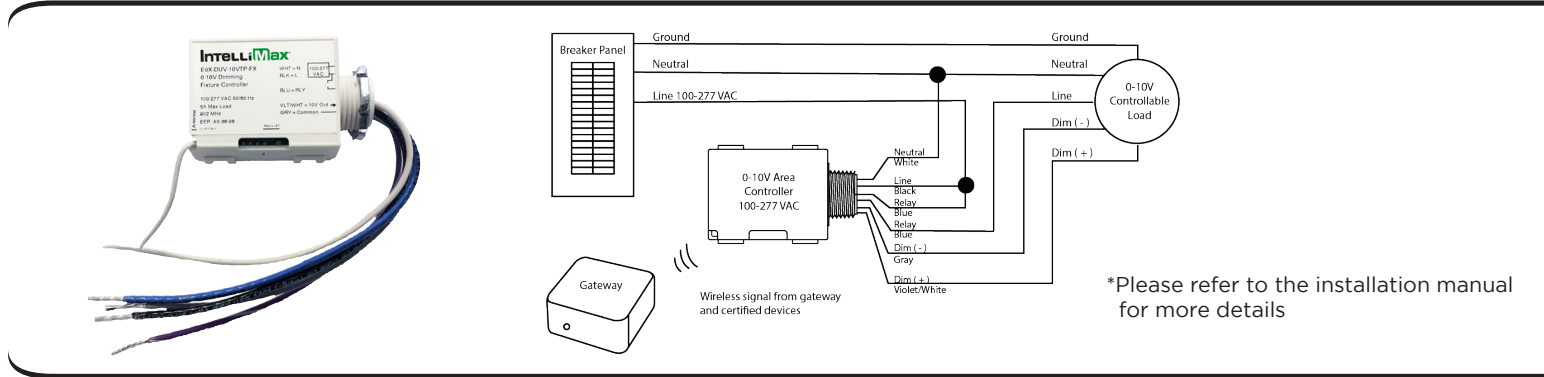

*Please refer to the installation manual for more details

FEATURES:

- Control up to 20A loads
- Less than 0.5W standby power
- Certified for the Cortet IoT Control Platform for smart lighting control
- IOS/Android mobile app control with the Cortet Smart Control App

APPLICATIONS:

- Conference Rooms
- Houses of Worship
- Classrooms
- Offices
- Daylight Harvesting

COMPATIBLE WITH:

- Cortet™ Gateways
- Cortet Certified Devices
- Any HA1.2 Zigbee Gateway

COMPATIBLE LOADS:

- LED
- Fluorescent
- HID, etc.
- Any <20A 0-10V controllable load

SPECIFICATIONS:







SPECIFICATIONS	DETAILS
Frequency	902MHz
Device Network Interface	ZigBee
Supply Voltage	100-277 VAC 50/60 Hz
Standby Power	<0.5W
Max Load	20 Amps Resistive, Induction, Fluorescent, LED, Other 160A Max Inrush Current 0-10V sink 100mA, 0-10V source 1mA
Dimensions	2.61" x 1.73" x 1.09" (66mm x 44mm x 28mm)
Range	50-150 Ft
Operating Temperature	32°F to 122°F (0°C to 50°C)
Storage Temperature	-4°F to 176°F (-20°C to 80°C)
Approvals	ETL: UL 60730 (U.S.), CSAc22.2#1405(Canada), UL 2043 (PLENUM), CE: IEC 60730, IEC6100045(SURGE), FCC: SZVSTM300U(UNITED STATES), IC: 5713ASTM300U(CANADA)
Relative Humidity	10-90%, non-condensing
Usage	Indoor Only
Warranty	Limited 5-Year

ORDERING:

MODEL NUMBER	ORDER CODE	DESCRIPTION
IM-NODE-20	1409232	IntelliMax Fixture Relay Node

IntelliMax Node Controller

INTELLIMAX COMPATIBLE PRODUCTS:

INTELLIMAX PRODUCT	ORDER CODE	ITEM NUMBER	IMAGE
IntelliMax Gateway	1408934	IM-GWE1100W	
IntelliMax Gateway Mini Hub	1408936	IM-HBE100W	
IntelliMax Range Extender	1408938	IM-REEZ10W	
IntelliMax Occupancy Sensor	1408945	IM-MSZSC15	
IntelliMax Daylight Sensor	1409568	IM-PCLURPC-OCW	
IntelliMax Wall Switch	1410141	IM-WSNDL15S	
IntelliMax Wall Switch/Dimmer	1410149	IM-WSDDL1KD	