

HIGHMAX CFLs

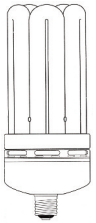

SKQ40EA
SKQ40EA50
SKQ40EA250
SKQ40EA350

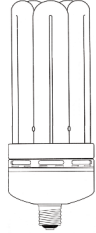

SKQ60EA
SKQ60EA50
SKQ60EA250
SKQ60EA350

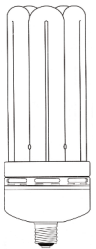

SKQ80EA
SKQ80EA50
SKQ80EA250
SKQ80EA350

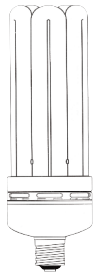

SKQ100EA
SKQ100EA50
SKQ100EA250
SKQ100EA350

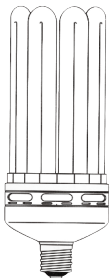

SKO150EA
SKO150EA50
SKO150EA250
SKO150EA350



SKO200EA
SKO200EA50
SKO200EA250
SKO200EA350

U.S. PATENT NUMBER 8115368

For more information on MaxLite products, visit:
www.maxlite.com

FOR ORDERING:

Tel: 1-800-555-5629
Fax: 973-244-7333
E-mail: info@maxlite.com

MaxLite
12 York Ave
West Caldwell, NJ 07006



MAX12047

PRODUCT FEATURES:

- High Lumens (up to 12,000) using less energy
- Long Life - 10,000 Hour▲
- Shortened MOL to fit common fixtures
- Self Ballasted / Instant-on
- Available in 120V, 277V, and 347V with edison or mogul base, in 2700K and 5000K

▲ MTF - Mean Time to Failure

MAXLITE® HIGHMAX CFLs

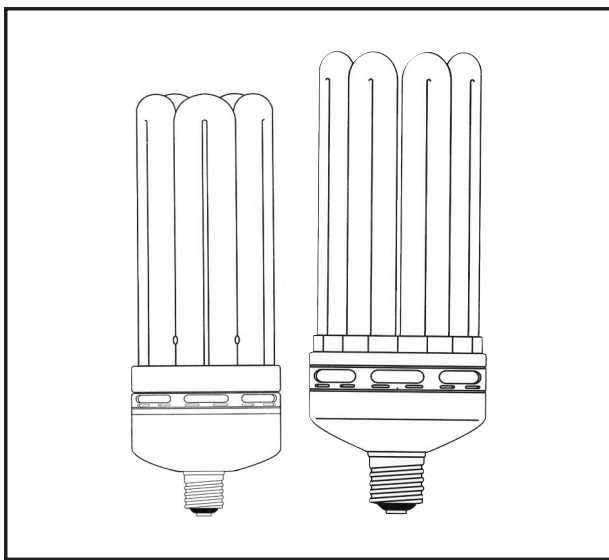

Lamp: The HighMax is a high wattage, self ballasted, instant on compact fluorescent lamp. The lamps comprise both 5U and 8U models and the wattages run from 40 watts through 200 watts. The HighMax is available for both 120 Volts and 277 Volts, with some models also available in 347 Volts (Canada).

Lumen Maintenance/ Heat Management: All HighMax Models are designed to manage heat so that lumen maintenance is maximized. Critical components (susceptible to heat failure) are chosen for their high heat tolerance. The body of the lamp is vented with patented air gaps to increase cooling air flow. And, placed between the heat producing and heat-sensitive components is a thick aluminum wafer. This barrier is a heat sink, removing additional heat from the lamp.

Uses: For high and low bays, gymnasiums, warehouses, churches, wall packs, shop floors and parking garages

LIFE: 10,000 hours all models ▲

▲ MTF = Mean time to Failure

PACK: All lamps are individually boxed

CASE: 6 units per case

PRODUCT FEATURES:

- High Lumens (up to 12,000) using less energy
- Long life - 10,000 Hour ▲
- Shortened MOL to fit common fixtures
- Self Ballasted / Instant-on
- Available in 120V, 277V, and 347V, with edison or mogul base in 2700K and 5000K

Watts	Order Code	Description	Voltage	HID Equivalent	Lumens	Scotopic Lumens	Efficacy (LM/W)	Power Factor	Current	Dimensions (W"xMOL")	K
40	11212	SKQ40EAWW 5U E26	120	100MH	3,000	n/a	75	0.5	0.67	3.5 x 6.8	2700
40	11211	SKQ40EA50 5U E26	120	100MH	3,000	5,900	75	0.5	0.67	3.5 x 6.8	5000
40	11183	SKQ40EA250 5U E26	277	100MH	3,000	5,900	75	0.9	0.16	3.5 x 6.8	5000
40	11291	SKQ40EA350 5U E26	347	100MH	3,000	5,900	75	0.9	0.13	3.5 x 6.8	5000
60	11272	SKQ60EAWW 5U E26	120	175MH	4,200	n/a	70	0.5	1.00	3.5 x 9.1	2700
60	11271	SKQ60EA50 5U E26	120	175MH	4,200	8,232	70	0.5	1.00	3.5 x 9.1	5000
60	11270	SKQ60EA250 5U E26	277	175MH	4,200	8,232	70	0.9	0.24	3.5 x 9.1	5000
60	11292	SKQ60EA350 5U E26	347	175MH	4,200	8,232	70	0.19	0.24	3.5 x 9.1	5000
80	11275	SKQ80EAWW 5U E26	120	175MH	5,500	n/a	68	0.5	1.33	3.5 x 10.4	2700
80	11274	SKQ80EA50 5U E26	120	175MH	5,500	10,780	68	0.5	1.33	3.5 x 10.4	5000
80	11273	SKQ80EA250 5U E26	277	175MH	5,500	10,780	68	0.9	0.32	3.5 x 10.4	5000
80	11293	SKQ80EA350 5U E26	347	175MH	5,500	10,780	68	0.9	0.26	3.5 x 10.4	5000
100	35844	SKQ100EAWW 5U E39	120	250MH	6,900	n/a	69	0.5	1.67	3.5 x 12.5	2700
100	35840	SKQ100EA50 5U E39	120	250MH	6,900	13,524	69	0.5	1.67	3.5 x 12.5	5000
100	35839	SKQ100EA250 5U E39	277	250MH	6,900	13,524	69	0.9	0.40	3.5 x 12.5	5000
100	11294	SKQ100EA350 5U E39	347	250MH	6,900	13,524	69	0.9	0.32	3.5 x 12.5	5000
150	35862	SKO150EAWW 8U E39	120	250-400W MH	9,200	n/a	61.3	0.5	2.50	5.0 x 12.5	2700
150	35861	SKO150EA50 8U E39	120	250-400W MH	9,200	18,032	61.3	0.5	2.50	5.0 x 12.5	5000
150	35863	SKO150EA250 8U E39	277	250-400W MH	9,200	18,032	61.3	0.9	0.60	5.0 x 12.5	5000
150	11295	SKO150EA350 8U E39	347	250-400W MH	9,200	18,032	61.3	0.9	0.48	5.0 x 12.5	5000
200	35872	SKO200EAWW 8U E39	120	400MH	12,000	n/a	60	0.5	3.33	5.0 x 13.75	2700
200	35871	SKO200EA50 8U E39	120	400MH	12,000	23,520	60	0.5	3.33	5.0 x 13.75	5000
200	35873	SKO200EA250 8U E39	277	400MH	12,000	23,520	60	0.9	0.80	5.0 x 13.75	5000
200	11296	SKO200EA350 8U E39	347	400MH	12,000	23,520	60	0.9	0.64	5.0 x 13.75	5000

MAX12047

U.S. PATENT NUMBER 8115368

Accessories

Watts	Order Code	Description
N/A	11259	SKXE40 Mogul to Edison socket converter

All specifications are subject to change without notice

MaxLite®: 1-800-555-5629 | Fax: 973-244-7333 | Web: www.maxlite.com | E-mail: info@maxlite.com

CA US
MAXLITE®
Revised: 03-20-13

MaxLite® HIGHMAX CFLs

DRAWINGS & DIMENSIONS

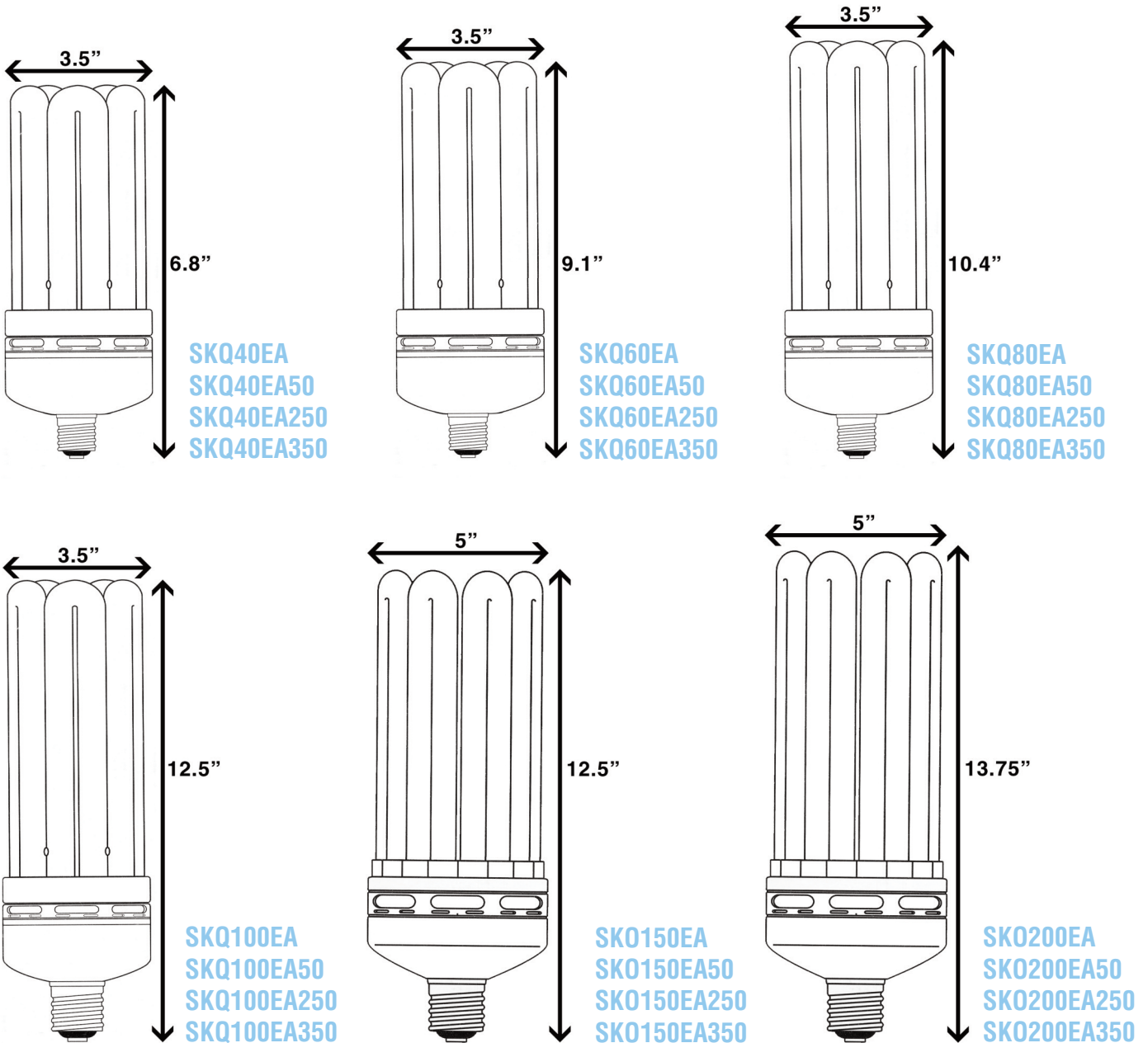

U.S. PATENT NUMBER 8115368

SPECIAL NOTES	SPECIFICATIONS
<ul style="list-style-type: none"> • Available with MaxLite's HighBay retrofit kit for retrofitting HID fixtures • Also available with MaxLite's HighMax acrylic HighBay fixture for retrofit/new construction • 1 Year warranty from date of purchase, not suitable for outdoor use 	<ul style="list-style-type: none"> • Ballast Type >> Electronic • Starting Method >> Instant Start • Input Line Voltage >> 120-347VAC • Input Line Frequency >> 50/60HZ • Operating Temperature >> 0°-100°F • Color Rendering Index >> 84

MAX12047

All specifications are subject to change without notice

Contains Mercury (Hg) Dispose of according to Local, State, and Federal Law / www.lamprecycle.org